



Flyer

# ABB DC Drives DCS800-A, 18 A to 9800/19600 A

## Enclosed converters

Power and productivity  
for a better world™



# DCS800-A Enclosed Converters

## Latest Technology, High Performance and a User-Friendly Concept

DCS800-A are DCS800 converter modules mounted in an enclosure.

The series is a complete range of enclosed converters intended for the supply and control of DC machines. DCS800-A provides maximum flexibility in the firmware, the drive itself is programmable as well as a serial communication (e.g. Profibus) interface plus 12-pulse parallel, serial and sequential.

DCS800-A enclosed converters are fully digital. Optional equipment is available to meet different safety standards. The converter can be used for standard applications but has the flexibility to be customized for the most demanding applications.

## Comprehensive Product Range

DCS800-A enclosed converters are available as 6-/ 12-pulse and in 2- or 4-quadrant, with current ranges from 18 to 9800/19600 A and supply voltages of 230...990 (1200) V AC. A selection of options is available to provide the user with a system meeting the most demanding technical requirements and performance expectations. Common control electronics throughout the product range reduces spare parts inventory and training requirements.

## DCS800-A Concept

- A single drive control technology is available for a wide power range to reduce training costs and meets the requirements of various applications.
- Common AC busbar designs for group drives are available for the most cost-efficient and functional system structure.
- Incoming supply section for group drives can be equipped with air circuit breakers or insulation switches.
- Control cubicles offer various I/O solutions in combination with ABB controls e.g. AC800M.
- Approval for many application specific standards (e.g. ABS, DNV, Lloyd, UL, CSA) can be ordered as option.



- Flexible design of power cable entry provide simple installation and minimum power down time especially for upgrades.

## Digital Control

To meet the most stringent control requirements, the DCS800-A features speed control, which reduces the effects from gear backlash and torsional vibration arising in



mechanical systems. High-performance speed and torque control will fulfill all requirements for rapid response and high control accuracy. Autotuning for armature, field current and speed controller simplifies the commissioning.

## What is a DCS800 DC drive?

The DCS800 DC Drive is simple to buy, install, configure and use, saving considerable time.

- Precise delivery
- Quick installation
- Rapid start-up

The drive has common user and process interface with fieldbus, common software tools for sizing, commissioning, maintenance and common spare parts.

## Where can it be used?

DCS800 can be used in the wide range of all industrial application of

- |                     |                    |
|---------------------|--------------------|
| ■ Metals            | ■ Vessels          |
| ■ Pulp & Paper      | ■ Ski lifts        |
| ■ Material handling | ■ Magnets          |
| ■ Test rigs         | ■ Mining           |
| ■ Food & Beverage   | ■ Electrolysis     |
| ■ Printing          | ■ Battery Chargers |
| ■ Plastic & Rubber  | ■ and more         |

## DCS800 DC drive promises

The drive meet the requirement of all demanding drive application like: • testrig • mine hoist • rolling mill as well as none motoric applications like: electrolysis • magnetics • battery charger ...

Embedded software functions offer the upgrades of all classic installations 12-pulse, shared motion, double motor operation, field reversal control.



## Highlights

- Assistant control panel providing intuitive use of the drive.
- Excellent control performance up to highest dynamic application in field weakening operation.
- All ACS800 PC tools (via DDCS) can be connected
- Reduced installation and commissioning work.
- Internal three phase field exciter without additional external hardware.
- Prepared for additional software function by adaptive programming and IEC61131 programming.
- Flexible fieldbus system with built-in Modbus and numerous internally mountable fieldbus adapters.

## Software Tools

### Start-up assistant

Faster and easier commissioning

The Start-up assistant serves in DCS800 DC Drives. It guides you actively through the commissioning procedure either by the control panel or ABB PC tools. It is multilingual, requests data with clear and plain text messages, and sets the required parameters to your needs. It also comes with an online info system with step-by-step reference to printed manuals.

### IEC 61131 programming

ControlBuilder DCS800

The ControlBuilder is a user-friendly tool based on the IEC61131-3 standard for programming the DCS800. With the ControlBuilder it is possible to develop - in a fast and easy way - new function e.g. winders, decentralized controls, safety functions, ... directly in the drive.

### Fieldbus control

Gateway to your process

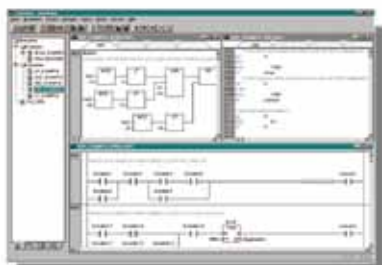

DCS800 DC Drives have connectivity to major automation systems. This is achieved with a dedicated gateway concept between the fieldbus systems and ABB drives. The fieldbus gateway module can easily be mounted inside the drive. As a result of the wide range of fieldbus gateways, your choice of automation system is independent from your decision to use first-class ABB drives.

### Start-up and maintenance tool

DriveWindow Light 2

PC tool for ABB drives

DriveWindow Light 2 is an easy-to-use start-up and maintenance tool for ABB drives. Supported drives are ACS140, ACS160, ACS350, ACH400, DCS400, ACS550, ACH550, DCS800 and ACS800.

- Viewing and setting parameters in offline and online mode
- Editing, saving and downloading parameters
- Comparing parameters
- Graphical and numerical signal monitoring
- Drive control
- Start-up assistants
- DWL AP tool for DCS800
- All DCS800 DC drives are equipped with DriveWindow Light

### Start-up, maintenance and integration

DriveWindow 2

ABB's DriveWindow is an advanced, easy-to-use PC software tool for the start-up and maintenance of ABB DCS800 DC Drives. Its host of features and clear, graphical presentation of the operation make it a valuable addition to your system providing information necessary for troubleshooting, maintenance and service, as well as training.

With DriveWindow the user is able to follow the co-operation of several drives simultaneously by collecting the actual values from the drives onto a single screen or printout.

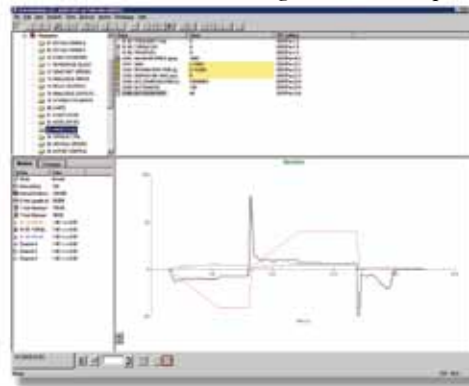

### DriveOPC

Integration tool

DriveOPC is a software package which allows OLE for Process Control (OPC) communication between Windows applications and DCS800 DC drives. It allows Object Linking and Embedding (OLE) for Process Control (OPC) communication. This OPC server is an ideal tool for integrating DCS800 DC drives and commercial PC software and creating PC-based controlling and monitoring systems.

## DCS800-A enclosed converters

DCS800-A enclosed converters are suitable for three-phase supply voltages from 230 V to 990 (1200) V, 50 or 60 Hz. The rated DC current range is from 18 to 9800/19600 A.

DCS800-A enclosed converters with rated DC current from 18 A up to 1850 A are available in two different layouts:

- Single drive configuration without horizontal busbars therefore AC cable connection
- Group drive configuration with horizontal busbars (size depending on rated amps)

The standard configuration is protection class IP21 and cable connection from bottom.

Group drives from sizes D6 and D7 on request. DCS800-A can be tailored to meet different needs by using combinations of the following options:

- Earth Fault Detection (current sensitive)
- Insulation Monitor (voltage sensitive)
- Motor Fan Starter
- Galvanic Isolation of converter voltage measurement
- Cabinet design according to EMC-regulations
- EMC Filters
- Protection Class IP 21- Standard
- Protection Class IP 31 with filter (insect screen) in air inlet and outlet
- Protection Class IP 42 with filter in air inlet; air outlet same as IP 21
- IP 54 on request
- Gland plate and bottom plate
- Special Colour (only outside) acc. to RAL standard
- Heater
- Lighting
- Horizontal Busbars

## DCA 650 Control Cabinet

Advant controller AC 800 • Fieldbus interface FCI (AF100)  
• Location of full range of S800 I/O modules.

The S800 I/O system consists of the control module (AC 80, FCI, AC 800M), digital and analogue I/O modules.

### Digital inputs and outputs

8 channels • input voltages from 24V...250V

### Analogue inputs and outputs (12 bit resolution)

8 channels

### Drive Bus Communication

CI854 provides fast optical DDCS communication

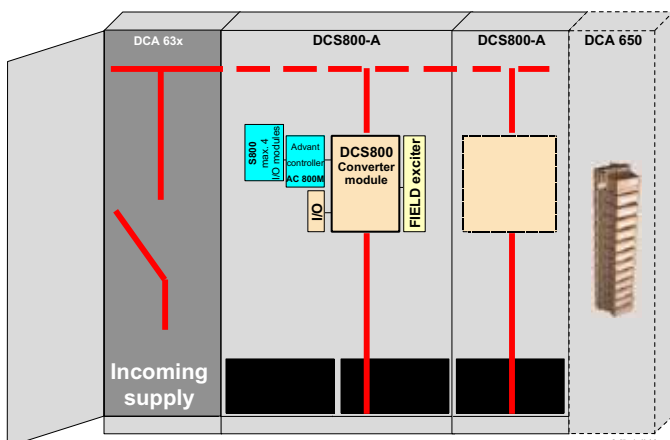

## Incoming Supply Sections for Group Drives

Incoming supply sections (DCA 63x) are used to supply several droup drives connected by horizontal busbars. The connection to the AC supply can be made by cables or busbars. The cable / busbar entry is at the bottom of the incoming supply section.

The incoming supply section can be located preferable left side of line-ups, but also right side and even in the middle of line-ups.

### Options

- Cabinet design according to EMC-regulations
- Isolation Switch (DCA 631)
- Breaker (DCA 632)
- Earthing switch
- Residual Current Detection
- AC Current Measurement
- AC Voltage Measurement
- Arc Detecting Relay
- Emergency stop relays, tripping circuits

## Field Exciters

### Several Solutions available

- Ratings from 6 to 450 A
- Integrated, separate or external
- 2-phase or 3-phase versions
- 1-; 2-; 4-Quadrant
- Digital control
- Auto/manual tuning

The field exciters are controlled via a serial DCS-link with a speed of 500 kBaud for fast and accurate control.

**On board** field exciters are 3-phase half controlled field exciters 6 A / 15 A / 20 A / 25 A in D1 up to D4 converter modules (525 V).

**FEX425** field exciter is also a 25 A 3-phase half controlled unit assembled in a D5 converter module.

### DCF803: 0050 B

2-phase, 1-quadrant, half controlled

### DCF804: 0050 B

2-phase, 4-quadrant, full controlled (field reversal)

### DCS800-A21: 18...400 A (2-Q), DCS800-A22: 22...450 A (4-Q)

18...400 (22...450) A, 3-phase, full controlled, separate cabinet including overvoltage protection

### DCS800-F01: 18...285 A (2-Q), DCS800-F02: 22...300 A (4-Q)

18...285 (22...300) A, 3-phase, inside D6/D7 armature cabinet is possible; including overvoltage protection

## DCS800 Converter modules

### Basic design

The DCS800 flexibility allows the user to configure functions of the drive easily, suitable for different applications. The basic firmware includes following options:

- Processing the speed reference with a speed ramp generator (S-ramp capability, accel/decel ramp)
- Processing the speed feedback
- Speed controller
- Torque reference processing
- Current controller
- Field weakening
- Automatic/manual field reversal
- Autotuning of current controller
- Autotuning of speed controller
- Speed monitor
- Drive control logic
- Remote/local operation
- Emergency stop
- Electronic circuits are not sensitive to line phase sequence
- Motor overload protection
- Dual field
- Programmable analogue outputs
- Field supply
- Master/follower via fibre optic
- 12-Pulse link

### I/O's of the converter module

- SDCS-IOB-23 + IOB-3 standard configuration
- RDIO, RAIO, AMIA as option

## DCS800-A Enclosed Converter unit types

Unit type	DC I * [A]	DC II current		DC III current		DC IV current		int. field current [A]	Power loss [kW]	Frame size
		100 % 15 min [A]	150 % 60 sec. [A]	100 % 15 min [A]	150 % 120 sec. [A]	100 % 15 min [A]	200 % 10 sec. [A]			
<b>400 V / 525 V</b>										
DCS800-A01-0020-04/05-D	18	17	25	16	25	14	28	6	<0.58	D1
DCS800-A02-0025-04/05-D	22	21	32	20	31	18	35	6	<0.58	
DCS800-A01-0045-04/05-D	40	35	52	32	48	31	62	6	<0.65	
DCS800-A02-0050-04/05-D	45	40	59	37	56	36	72	6	<0.65	
DCS800-A01-0065-04/05-D	60	46	69	43	64	43	86	6	<0.72	
DCS800-A02-0075-04/05-D	67	53	80	50	75	50	100	6	<0.72	
DCS800-A01-0125-04/05-D	115	87	130	83	123	83	166	6	<1.00	D2
DCS800-A02-0140-04/05-D	125	95	142	91	136	91	186	6	<1.00	
DCS800-A01-0230-04/05-D	200	140	200	130	190	120	248	15	<1.51	
DCS800-A02-0260-04/05-D	230	159	239	150	225	132	264	15	<1.51	
DCS800-A01-0315-04/05-D	285	219	329	211	316	192	384	20	<1.89	
DCS800-A02-0350-04/05-D	300	228	342	222	333	200	400	20	<1.89	
DCS800-A01-0470-04/05-D	400	308	462	290	435	275	550	20	<2.57	D4
DCS800-A02-0520-04/05-D	450	345	517	330	495	308	616	20	<2.57	
DCS800-A01-0610-04/05-D	540	432	648	427	641	391	781	25	<3.01	
DCS800-A02-0680-04/05-D	600	480	720	475	712	434	868	25	<3.01	
DCS800-A01-0740-04/05-D	680	551	826	537	806	488	977	25	<3.65	
DCS800-A02-0820-04/05-D	750	607	911	593	889	539	1077	25	<3.65	
DCS800-A01-0900-04/05-D	810	620	931	596	894	547	1094	25	<4.80	D5
DCS800-A02-1000-04/05-D	900	689	1034	662	994	608	1215	25	<4.80	
<b>400 V / 500 V</b>										
DCS800-A0x-1200-04/05-D	1140	843	1265	820	1230	731	1461	25 ⑤	<7.64	D5
DCS800-A0x-1500-04/05-D	1425	1140	1709	1048	1573	1048	2097	25 ⑤	<10.34	
DCS800-A0x-2000-04/05-D	1850	1368	2052	1259	1889	1259	2518	25 ⑤	<10.62	D6
DCS800-A0x-2050-05-D ③	1950	1550	2325	1480	2220	1450	2900		<9.70	
DCS800-A01-2500-04/05-D ③	2450	1980	2970	1880	2820	1920	3840		<10.20	D7
DCS800-A02-2500-04/05-D ③	2450	2000	3000	1930	2895	1790	3580		<11.20	
DCS800-A01-3000-04/05-D	3000	2350	3525	2220	3330	2280	4560		<11.90	
DCS800-A02-3000-04/05-D	3000	2330	3495	2250	3375	2080	4160		<13.70	
DCS800-A0x-3300-04/05-D ①	3300	2300	3450	2250	3375	2130	4260		<17.20	
DCS800-A0x-4000-04/05-D ②	4000	2800	4200	2730	4095	2600	5200		<18.00	
DCS800-A0x-5200-04/05-D ②	5100 ④	3850	5775	3750	5625	3650	7300		<23.50	D7P
DCS800-A0x-6600-04/05PD ②	6200	4370	6555	4275	6412	4047	8094		<34.40	
DCS800-A0x-8000-04/05PD ②	7600	5320	7980	5187	7780	4940	9880		<36.00	
DCS800-A0x-10400-04/05PD ②	9800	7315	10971	7125	10687	6935	13870		<47.00	
<b>600 V / 690 V</b>										
DCS800-A01-0290-06-D	220	174	260	152	228	152	304		<1.81	D3
DCS800-A02-0320-06-D	240	190	285	166	249	166	332		<1.81	
DCS800-A01-0590-06-D	370	290	435	258	387	258	516		<2.47	D4
DCS800-A02-0650-06-D	400	313	469	279	418	279	558		<2.47	
DCS800-A0x-0900-06/07-D	855	650	974	565	847	565	1129	25 ⑤	<7.20	D5
DCS800-A0x-1500-06/07-D	1425	1140	1709	1048	1573	1048	2097	25 ⑤	<10.34	
DCS800-A01-2000-06/07-D	1850	1368	2052	1259	1889	1259	2518	25 ⑤	<10.62	D6
DCS800-A0x-2050-06/07-D ③	1950	1520	2280	1450	2175	1430	2860		<10.70	
DCS800-A01-2500-06/07-D ③	2450	1940	2910	1840	2760	1880	3760		<11.70	D7
DCS800-A02-2500-06/07-D ③	2450	1940	2910	1870	2805	1740	3480		<12.80	
DCS800-A01-3000-06/07-D	3000	2530	3795	2410	3615	2430	4860		<13.10	
DCS800-A02-3000-06/07-D	3000	2270	3405	2190	3285	2030	4060		<14.50	
DCS800-A0x-3300-06/07-D ①	3300	2360	3540	2310	3465	2180	4360		<17.90	
DCS800-A0x-4000-06/07-D ②	4000	3000	4500	2850	4275	2900	5800		<20.10	
DCS800-A0x-4800-06/07-D ②	4700 ④	3600	5400	3500	5250	3600	7200		<23.70	D7P
DCS800-A0x-6600-06/07PD ②	6200	4484	6726	4389	6583	4142	8284		<35.70	
DCS800-A0x-8000-06/07PD ②	7600	5700	8550	5415	8122	5510	11020		<40.20	
DCS800-A0x-9600-06/07PD ②	9000	6840	10260	6650	9975	6840	13680		<47.30	
<b>800 V</b>										
DCS800-A0x-1900-08-D ②	1900	1500	2250	1430	2145	1400	2800		<9.90	D6
DCS800-A01-2500-08-D ②	2500	1920	2880	1820	2730	1860	3720		<11.00	
DCS800-A02-2500-08-D ②	2500	1910	2865	1850	2775	1710	3420		<11.50	D7
DCS800-A01-3000-08-D ②	3000	2500	3750	2400	3600	2400	4800		<12.50	
DCS800-A02-3000-08-D ②	3000	2250	3375	2160	3240	2000	4000		<13.90	
DCS800-A0x-3300-08-D ②	3300	2350	3525	2300	3450	2170	4340		<18.10	
DCS800-A0x-4000-08-D ②	4000	2950	4425	2800	4200	2800	5600		<20.30	
DCS800-A0x-4800-08-D ②	4700 ④	3600	5400	3500	5250	3500	7000		<23.90	
DCS800-A0x-6600-08PD ②	6200	4465	6697	4370	6555	4123	8246		<36.00	D7P
DCS800-A0x-8000-08PD ②	7600	5605	8407	5320	7980	5320	10640		<40.50	
DCS800-A0x-9600-08PD ②	9000	6840	10260	6650	9975	6650	13300		<46.50	
<b>990 V</b>										
DCS800-A0x-2050-10-D ②	2050	1500	2250	1450	2175	1350	2700		<15.10	D7
DCS800-A0x-2600-10-D ②	2600	1850	2275	1800	2700	1700	3400		<18.50	
DCS800-A0x-3300-10-D ②	3300	2450	3675	2350	3525	2300	4600		<22.80	D7P
DCS800-A0x-4000-10-D ②	4000	2850	4275	2800	4200	2750	5500		<23.50	
DCS800-A0x-5200-10PD ②	4900	3515	5272	3420	5130	3230	6460		<36.80	
DCS800-A0x-6600-10PD ②	6200	4655	6982	4465	6697	4370	8740		<45.60	
DCS800-A0x-8000-10PD ②	7600	5415	8122	5320	7980	5225	10450		<46.80	
<b>1200 V</b>										
DCS800-A0x-2600-12-D ②	2600	1900	2850	1830	2745	1850	2775		<21.20	D7
DCS800-A0x-3300-12-D ②	3300	2390	3885	2310	3465	2310	4620		<22.80	
DCS800-A0x-4000-12-D ②	3800 A at 7% u <sub>cr</sub>		4000 A at 14% u <sub>cr</sub>						<24.50	

Table 1: DCS800-A types

x=1 ⇒ 2-Q converter

x=2 ⇒ 4-Q converter

P ⇒ hard parallel (two conv. mod. in parallel)

**Voltage class:** (example: DCS800-A0x-0025-04y-D)

04 ⇒ 400V 05 ⇒ 500/525V 06 ⇒ 600V 07 ⇒ 690V

08 ⇒ 800V 10 ⇒ 990V 12 ⇒ 1200V

\* Ratings are valid for IP 21; for IP 31 and IP 41 the current derating is calculated by DriveSize ① = Air circuit breaker on request ② = Air circuit breaker not available ③ = Reduced current due to standard air circuit breaker. Larger air circuit breakers are available on request ④ with air exit IP20 ⇒ plus 100 A ⑤ FEX425 internal field exciter as option; three-phase or single phase, separate supply max. 500 V AC

DCS800-A enclosed converters are suitable for three-phase supply voltages from:

**230...990 (1200) V AC  
50 or 60 Hz**

Select the DCS800-A type from Table 1, according to the nominal supply voltage and the rated DC current.

### Load cycles

DC I \* I<sub>DCI continuous</sub> (I<sub>dN</sub>)

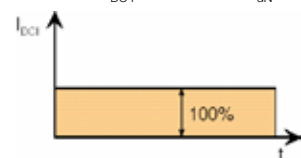

DC II I<sub>DCII</sub> for 15 min and 1.5 \* I<sub>DCII</sub> for 60 s

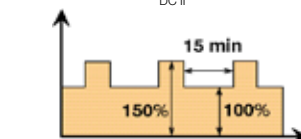

DC III I<sub>DCIII</sub> for 15 min and 1.5 \* I<sub>DCIII</sub> for 120 s

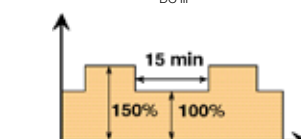

DC IV I<sub>DCIV</sub> for 15 min and 2 \* I<sub>DCIV</sub> for 10 s

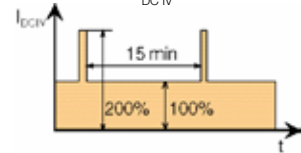

### Enclosed 3-phase Field exciters

Unit type	DC I [A]	Power loss [kW]	Size
<b>525 V</b>			
DCS800-A21-0020-05-D	16	0.58	D1
DCS800-A22-0025-05-D	22	0.58	
DCS800-A21-0045-05-D	40	0.65	
DCS800-A22-0050-05-D	45	0.65	
DCS800-A21-0065-05-D	57	0.72	
DCS800-A22-0075-05-D	67	0.72	
DCS800-A21-0090-05-D	84	0.85	D2
DCS800-A22-0100-05-D	92	0.85	
DCS800-A21-0180-05-D	160	1.40	D3
DCS800-A22-0200-05-D	180	1.40	
DCS800-A21-0315-05-D	285	1.89	D3
DCS800-A22-0350-05-D	300	1.89	
DCS800-A21-0405-05-D	340	2.40	D4
DCS800-A22-0450-05-D	380	2.40	
DCS800-A21-0610-05-D	520	3.00	
DCS800-A22-0680-05-D	520	3.00	

# Dimensions Converter cabinet

	Single drive					Group drive					
	Height ①	Depth ②	Width ③	Width ④	Weight [kg]	Height ①	Depth ②	Width ③	Width ④	Weight ⑦	
<b>DC-Converter, Size D1</b>											
DCS800-A0x-0020-04/05-D	2120	600	600	-	220	2120	600	600	-	190+z	
DCS800-A0x-0025-04/05-D	2120	600	600	-	220	2120	600	600	-	190+z	
DCS800-A0x-0045-04/05-D	2120	600	600	-	230	2120	600	600	-	200+z	
DCS800-A0x-0050-04/05-D	2120	600	600	-	230	2120	600	600	-	200+z	
DCS800-A0x-0065-04/05-D	2120	600	600	-	230	2120	600	600	-	200+z	
DCS800-A0x-0075-04/05-D	2120	600	600	-	230	2120	600	600	-	200+z	
DCS800-A0x-0125-04/05-D	2120	600	600	-	250	2120	600	600	-	220+z	
DCS800-A0x-0140-04/05-D	2120	600	600	-	250	2120	600	600	-	220+z	
<b>DC-Converter, Size D2/D3</b>											
DCS800-A0x-0200-04/05-D	2120	600	600	-	250	2120	600	600	-	220+z	
DCS800-A0x-0250-04/05-D	2120	600	600	-	250	2120	600	600	-	220+z	
DCS800-A0x-0315-04/05-D	2120	600	600	-	300	2120	600	600	-	270+z	
DCS800-A0x-0350-04/05-D	2120	600	600	-	300	2120	600	600	-	270+z	
DCS800-A0x-0470-04/05-D	2120	600	800	-	310	2120	600	800	-	280+z	
DCS800-A0x-0520-04/05-D	2120	600	800	-	310	2120	600	800	-	280+z	
<b>DC-Converter, Size D4</b>											
DCS800-A0x-0610-04/05-D	2120	600	800	-	360	2120	600	800	-	330+z	
DCS800-A0x-0680-04/05-D	2120	600	800	-	360	2120	600	800	-	330+z	
DCS800-A0x-0740-04/05-D	2120	600	800	-	360	2120	600	800	-	330+z	
DCS800-A0x-0820-04/05-D	2120	600	800	-	360	2120	600	800	-	330+z	
DCS800-A0x-0900-04/05-D	2120	600	800	-	360	2120	600	800	-	330+z	
DCS800-A0x-1000-04/05-D	2120	600	800	-	360	2120	600	800	-	330+z	
<b>DC-Converter, Size D5</b>											
DCS800-A0x-0900-06/07-D	2120	600	1400	-	620	2120	600	1400	-	590+z	
DCS800-A0x-1200-04/05-D	2120	600	1400	-	640	2120	600	1400	-	610+z	
DCS800-A0x-1500-04/05/06/07-D	2120	600	1400	-	720	2120	600	1400	-	690+z	
DCS800-A0x-2000-04/05/06/07-D ⑥	2120	600	1400	-	740	2120	600	1400	-	710+z	
<b>DC-Converter, Size D6</b>											
DCS800-A0x-1900-08-D ④	2120	600	-	2000	850	on request					
DCS800-A0x-2050-05/06/07-D ⑧	2120	600	2400	-	1100						
DCS800-A0x-2500-04/05/06/07-D ⑧	2120	600	2400	-	1100						
DCS800-A0x-2500-08-D ④	2120	600	-	2000	850						
DCS800-A0x-3000-04/05/06/07-D ⑧	2120	600	2400	-	1250						
DCS800-A0x-3000-08-D ④	2120	600	-	2000	950						
<b>DC-Converter, Size D7</b>											
DCS800-A0x-2050-10-D ④	2120	600	-	2100	790		not available				
DCS800-A0x-2600-10/12-D ④	2120	600	-	2100	850						
DCS800-A0x-3300-04/05/6/07/08/10/12-D ④	2120	600	-	2100	950						
DCS800-A0x-4000-04/05/06/07/08/10/12-D ④	2120	600	-	2700 ⑨	1170						
DCS800-A0x-4800-06/07/08-D ④	2120	600	-	2700 ⑨	1200						
DCS800-A0x-5200-04/05-D ④	2120	600	-	2700 ⑨	1200						
<b>DC-Converter, Size D7P</b>											
DCS800-A0x-5200-10PD	2120	600	-	3600	1430						
DCS800-A0x-6600-04/05/06/07/08/10PD	2120	600	-	3600	1630						
DCS800-A0x-8000-04/05/06/07/08/10PD	2120	600	-	4800 ⑨	2070						
DCS800-A0x-9600-06/07/08PD	2120	600	-	4800 ⑨	2140						
DCS800-A0x-10400-04/05PD	2120	600	-	4800 ⑨	2140						
<b>Incoming Supply Sections</b>											
DCA 63u-1000-04/05/06/07-D						2120	600	600	600	300	
DCA 63u-2000-4/5/6/7-D						2120	600	600	600	320	
DCA 63u-3000-4/5/6/7-D ⑩						2120	600	800	800	340	
DCA 63u-4000-4/5/6/7-D ⑩						2120	600	800	1000	380	
Busbar joining cabinet ⑨						2120	600	200	-	30+z	

## Fan data

Fan type	Air volume freely blowing [m³/h]		Converter size
	50 Hz	60 Hz	
2x CN2B2	320	360	D1 D2 D3
4x CN2B2	640	720	D3
W2E200 (230 V)	925	1030	0405...0520 D4
W2E200 (115 V)	925	1030	0610...0820 D4
W2E250 (230 V)	1860	1975	0900...1000 D4
W2E250 (115 V)	1835	1940	0900...1000 D4
D2E 160	800	750	D5
GR31M	1500	1600	D6 *
400...500 V			
GR31M	1500	1600	D6 *
500...690 V			
GR35C	4200	4250	D7 *
400/690V			
2x GR35C	8400	8500	D7P *
400/690V			

\* air outlet as air duct interface available

Table 2: Dimensions of the DCS800-A series.

x=1 ⇒ 2-Q converter  
x=2 ⇒ 4-Q converter  
u=0 ⇒ incoming without switch  
u=1 ⇒ incom. w. insulation switch  
u=2 ⇒ incom. w. circuit breaker  
P ⇒ hard parallel (two conv. mod. in parallel)  
u=5 ⇒ incom. without options

**Voltage class:** (example: DCS800-A0x-0025-04y-D)

04 ⇒ 400V    05 ⇒ 500/525V    06 ⇒ 600V    07 ⇒ 690V  
08 ⇒ 800V    10 ⇒ 990V    12 ⇒ 1200V

## Notes:

All dimensions are in mm  
Please add for each end panel 15 mm and for a door (without buttons) 20 mm

- Height is including detachable hood (120 mm)
- with circuit breaker or contactor
- without circuit breaker or contactor
- DCS800-A with AC supply voltage 3 x 800 V...1200 V or current ≥3300 A are generally without circuit breaker.
- Max length of a shipping split is 3.40 m. If the line-up width is longer than 3.40 m busbar joining cabinets are required.
- at 600 V (6) and 690 V (7) only available as 2-Q converter
- z: Weight for busbars: 1000 A/2000 A=35kg/m; 3000 A=70kg/m
- The air circuit breaker stands out of the line-up's front.  
Thus 78 mm have to be added to the total depth of the line-up.
- Listed width for cable connection  
reduced width for busbar connection on request
- DCA 632 rated current as IEC rating  
3000 A UL type on request

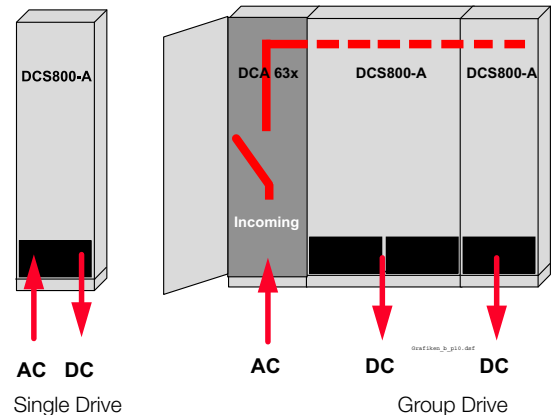

# DCS800 family



## DCS800-S modules

The versatile drive for any application

20 ... 5,200 A<sub>DC</sub>  
0 ... 1,160 V<sub>DC</sub>  
230 ... 1,000 V<sub>AC</sub>  
IP00

- Compact
- Highest power ability
- Simple operation
- Comfortable assistants, e.g. for commissioning or fault tracing
- Scalable to all applications
- Free programmable by means of integrated IEC61131-PLC



## DCS800-A enclosed converters

Complete drive solutions

20 ... 20,000 A<sub>DC</sub>  
0 ... 1,500 V<sub>DC</sub>  
230 ... 1,200 V<sub>AC</sub>  
IP21 – IP54

- Individually adaptable to customer requirements
- User-defined accessories like external PLC or automation systems can be included
- High power solutions in 6- and 12-pulse up to 20,000 A, 1,500 V
- In accordance to usual standards
- Individually factory load tested
- Detailed documentation



## DCS800-E series

Pre-assembled drive-kits

20 ... 2,000 A<sub>DC</sub>  
0 ... 700 V<sub>DC</sub>  
230 ... 600 V<sub>AC</sub>  
IP00

- DCS800 module with all necessary accessories mounted and fully cabled on a panel
- Very fast installation and commissioning
- Squeezes shut-down-times in revamp projects to a minimum
- Fits into Rittal cabinets
- Compact version up to 450 A and Vario version up to 2,000 A



## DCS800-R Rebuild Kit

Digital control-kit for existing powerstacks

20 ... 20,000 A<sub>DC</sub>  
0 ... 1,160 V<sub>DC</sub>  
230 ... 1,200 V<sub>AC</sub>  
IP00

- Proven long life components are re-used, such as power stacks, (main) contactors, cabinets and cabling / busbars, cooling systems
- Use of up-to-date communication facilities
- Increase of production and quality
- Very cost-effective solution
- Open Rebuild Kits for nearly all existing DC drives
- tailor-made solutions for...
  - BBC PxD
  - BBC SZxD
  - ASEA TYRAK
  - other manufacturers

# Contact us

## **ABB Automation Products**

Wallstadter Straße 59

68526 Ladenburg • GERMANY

Phone +49(0)6203-71-0

Fax +49(0)6203-71-7609

[www.abb.com/motors&drives](http://www.abb.com/motors&drives)

[dc-drives@de.abb.com](mailto:dc-drives@de.abb.com)